

# X-Large

# # XL 5414

## Notice de montage

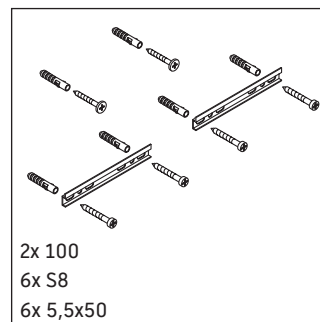
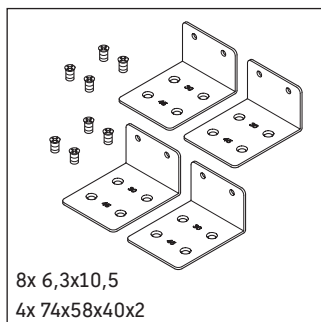
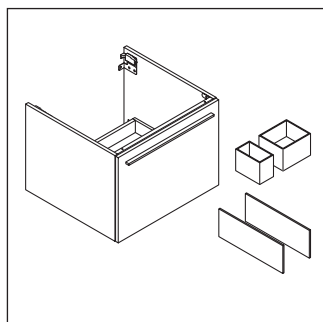
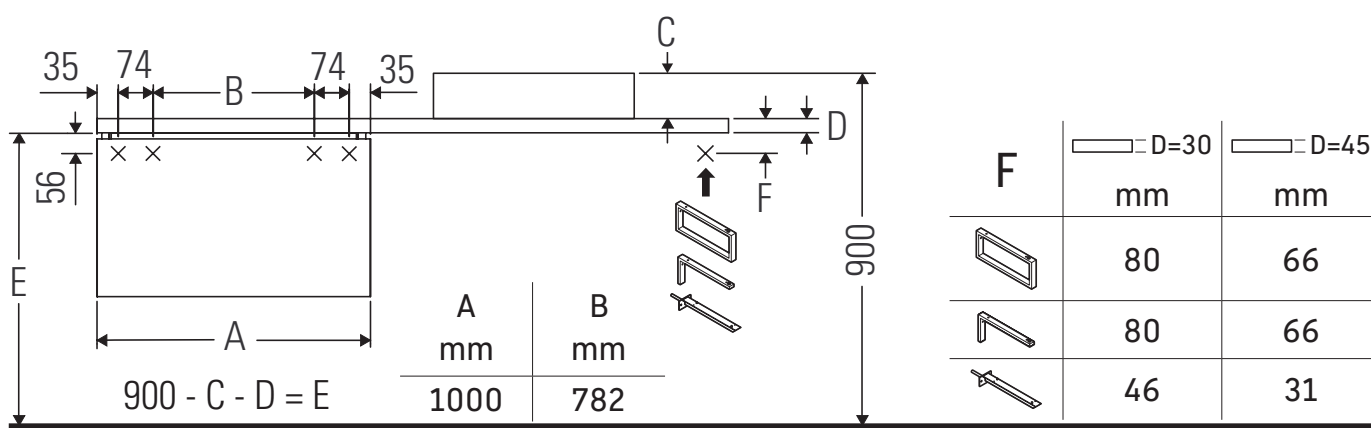

Respecter les cotes de perçage !



Se conformer à toutes les autres instructions de montage !

### Consignes d'utilisation

La série de meubles de salle de bain est conforme aux normes et directives en vigueur au moment de la livraison et a été conçue pour une utilisation dans les salles de bain. Éviter tout mouillage avec de l'eau, par ex. lors de la douche.

Les céramiques de largeur supérieure à 600 mm doivent être fixées au mur.

Nous nous réservons le droit d'apporter des améliorations techniques ou des modifications externes aux produits présentés.

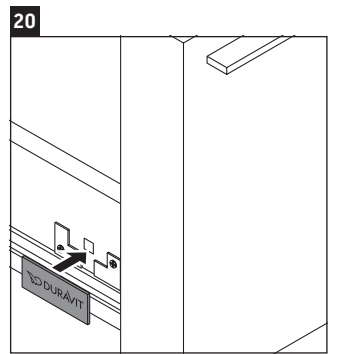
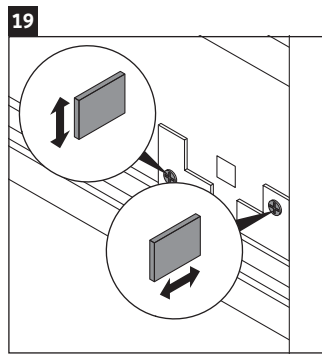
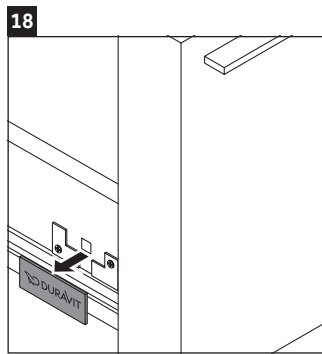
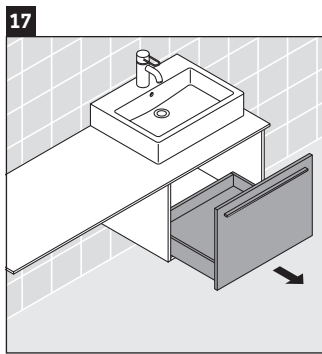
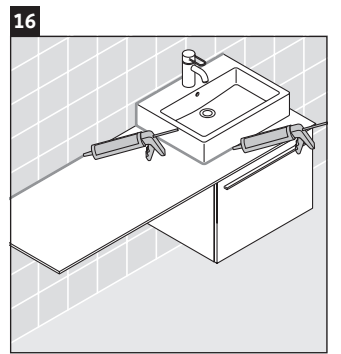
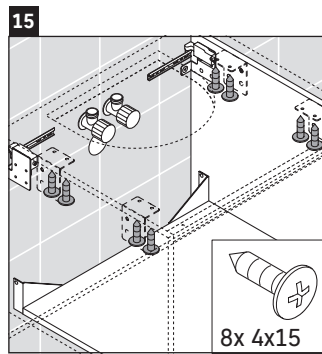
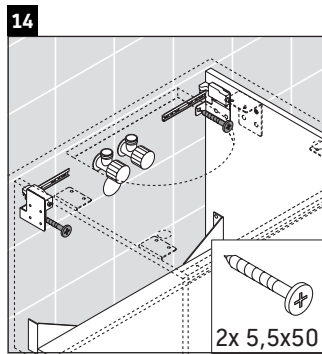
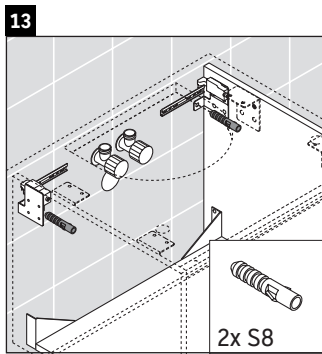
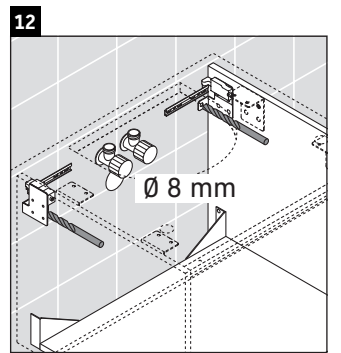
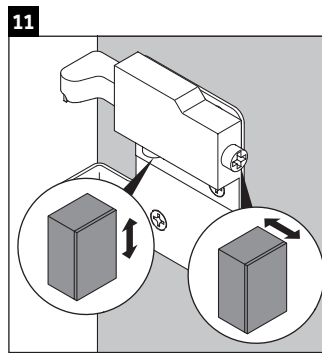
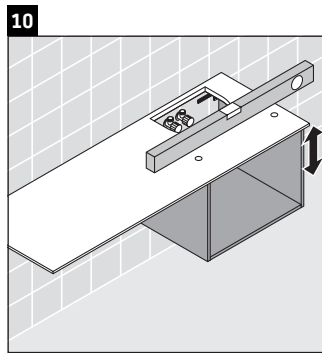
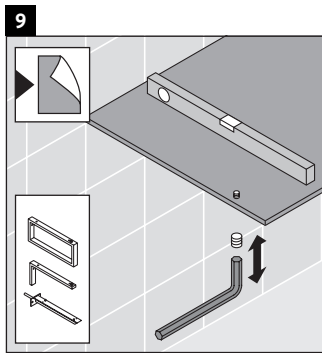
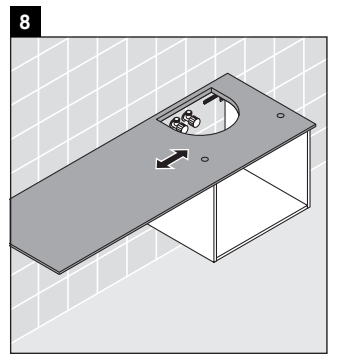
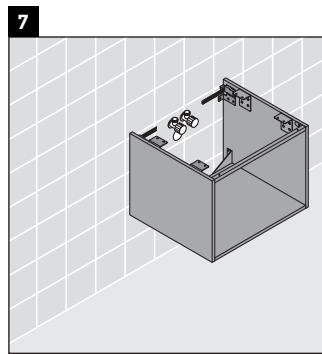
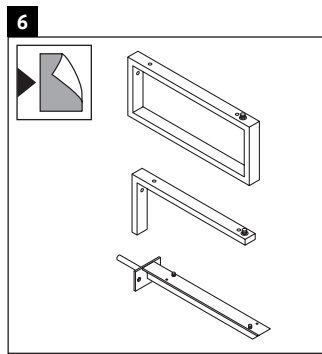
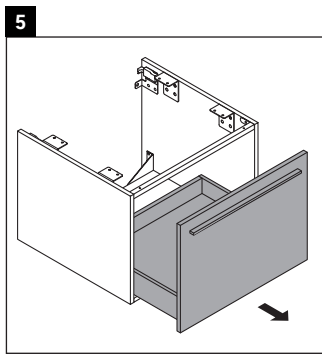

Best.-Nr. XL5414/16.11.1